

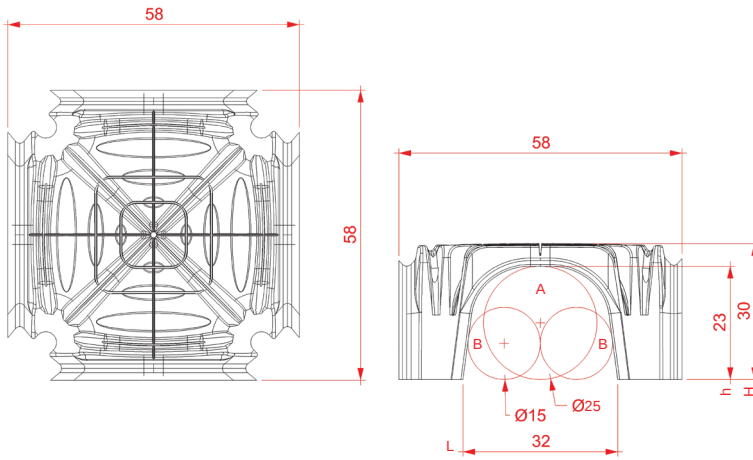

## DATOS TECNICOS STRONG 30



		H 30
Dimensiones	cm	58x58
Altura libre h	cm	23
Altura libre L	cm	32
Diam. max tubo A (1 tubo)	cm	25
Diam. max tubos B (2 tubos)	cm	15
Consumo de hormigon	m <sup>3</sup> /m <sup>2</sup>	0,044
Mq por palet	m <sup>2</sup>	110
Numero piezas por palet	pz	351
Dimensiones pallets 	A	110
	B	351
	C	235
PRECIO	D/mq	13,60