

## DATOS TECNICOS STRONG 15

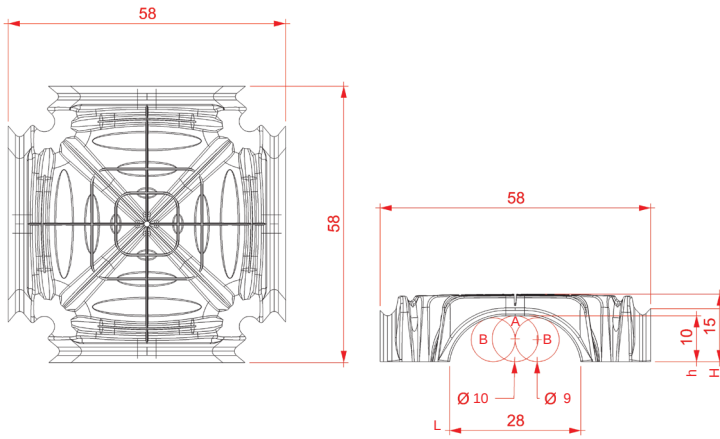

		H 15
Dimensiones	cm	58x58
Altura libre h	cm	10
Altura libre L	cm	28
Diam. max tubo A (1 tubo)	cm	10
Diam. max tubos B (2 tubos)	cm	9
Consumo de hormigon	m <sup>3</sup> /m <sup>2</sup>	0,027
Mq por palet	m <sup>2</sup>	120
Numero piezas por palet	pz	383
Dimensiones pallets	A	120
	B	120
	C	235



PRECIO

D/mq 11,76