

DATOS TECNICOS STRONG 60

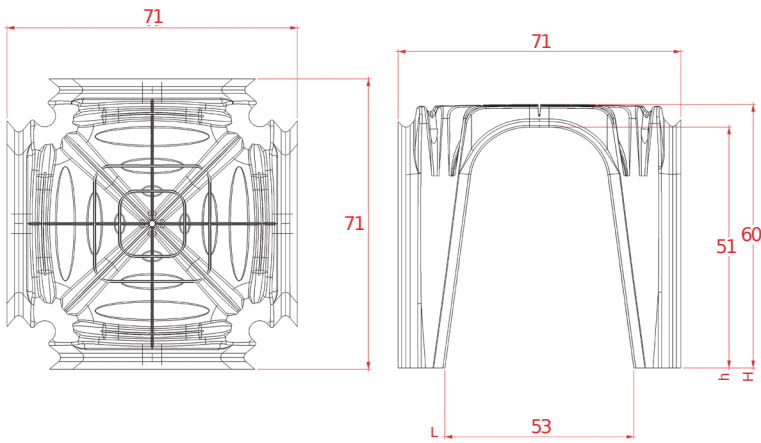

		H 60
Dimensiones	cm	71x71
Altura libre h	cm	51
Altura libre h	cm	53
Consumo de hormigon	m ³ /m ²	0,071
Mq por palet	m ²	100/50
PRECIO	D/mq	23,40