

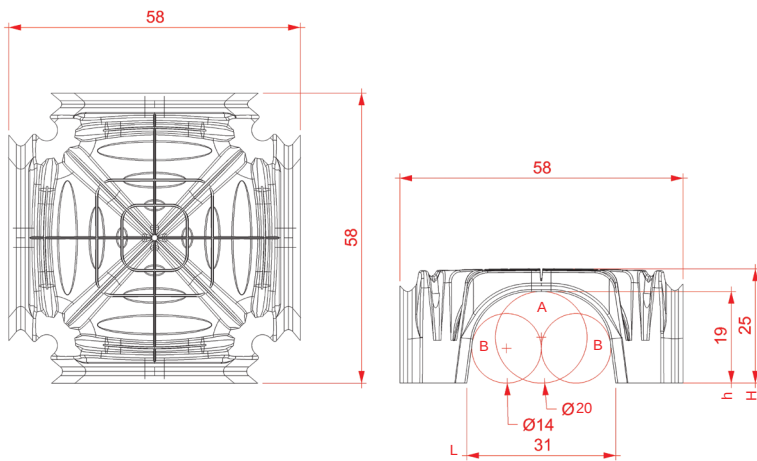

DATOS TECNICOS STRONG 25



		H 25
Dimensiones	cm	58x58
Altura libre h	cm	19
Altura libre L	cm	31
Diam. max tubo A (1 tubo)	cm	20
Diam. max tubos B (2 tubos)	cm	14
Consumo de hormigon	m ³ /m ²	0,040
Mq por palet	m ²	110
Numero piezas por palet	pz	351
Dimensiones pallets		A 120 B 120 C 235
PRECIO	D/mq	12,70